



National Power Corporation

SUPPLEMENTAL / BID BULLETIN NO. 2022-GOODS-053

to the Bidding Documents for the:

AG5 REPLACEMENT OF DWSG UNIT 2 HYDRAULIC SYSTEM AND CONTROL

(MG-A5M22-034/ PB-2022-009, ITEM NO. 3)

(Published on May 24, 2022, PhilGEPS)

All prospective bidders are hereby informed of the changes in some provisions of the tender documents as follows:

1. Clarifications/changes on the Conformity with the Technical Specifications – 2 (Administrative and Documentary Requirements) Item 5:

FROM:

Item	Description	NPC Requirements	Supplier's Data and Statement of Compliance
5	<p>Authority to Bid or Letter of confirmation from the manufacturer of</p> <ol style="list-style-type: none"> 1. Hydraulic Power Unit with Control Panels for (Integrated System); or 2. Motor and Pumps; and Oil Reservoir; and Control System for (Customized System) <p>that a local agent or representative is available to provide "After Sales Service" to the supplied Components / parts / accessories during and after the warranty period. Name, address and contact number shall be provided.</p>	<p>Submit the authority to bid or letter of confirmation as part of the eligibility requirements (To be included in Envelope 1) coming from:</p> <ol style="list-style-type: none"> 1. The Original Equipment Manufacturer (OEM) or its Philippine Subsidiary, or 2. Authorized Product Distributor. In this case, the bidder shall also submit the Distributorship Agreement (DA) between the manufacturer and the said authorized distributor. The DA must also indicate that the distributor is vested with authority to distribute the product in the Philippines. 3. If the bidder is an Authorized Distributor in the Philippines, submission of its DA with OEM in lieu of the required authority to bid will suffice. 	

NPC-009.F17
Rev.No.1
Page 1 of 4

BIR Road cor. Quezon Avenue, Diliman
Quezon City 1100, Philippines
Tel. Nos. (632) 921-3541 to 80
Fax No. (632) 921-2468
Website: www.napocor.gov.ph



Management System
ISO 9001:2015



www.tuv.com
ID 910605285

		The submitted Authority to Bid and Distributorship Agreements should indicate the validity period and must still be valid during the opening of bids.	
--	--	---	--

TO:

Item	Description	NPC Requirements	Supplier's Data and Statement of Compliance
5	<p>Authority to Bid or Letter of confirmation from the manufacturer of</p> <ol style="list-style-type: none"> Hydraulic Power Unit with Control Panels including the Multi-parameter Sensor and Data Logger for (Integrated System); or Motor and Pumps, Oil Reservoir, Control System, Multi-parameter Sensor and Data Logger for (Customized System) <p>that a local agent or representative is available to provide "After Sales Service" to the supplied Components / parts / accessories during and after the warranty period. Name, address and contact number shall be provided.</p>	<p>Submit the authority to bid or letter of confirmation as part of the eligibility requirements (To be included in Envelope 1) coming from:</p> <ol style="list-style-type: none"> The Original Equipment Manufacturer (OEM) or its Philippine Subsidiary, or Authorized Product Distributor. In this case, the bidder shall also submit the Distributorship Agreement (DA) between the manufacturer and the said authorized distributor. The DA must also indicate that the distributor is vested with authority to distribute the product in the Philippines. If the bidder is an Authorized Distributor in the Philippines, submission of its DA with OEM in lieu of the required authority to bid will suffice. <p>The submitted Authority to Bid and Distributorship Agreements should indicate the validity period and must still be valid during the opening of bids.</p>	

NPC-009.F17
Rev.No.1
Page 2 of 4

BIR Roadcor, Quezon Avenue, Diliman
Quezon City 1100, Philippines
Tel. Nos. (632) 921-3541 to 80
Fax No. (632) 921-2468
Website: www.napocor.gov.ph



Management System
ISO 9001:2015



www.tuv.com
JD 9104052016

**2. Clarifications/changes on the Conformity with the Technical Specifications – 2
(Administrative and Documentary Requirements) Item 8:**

FROM:

Item	Description	NPC Requirements	Supplier's Data and Statement of Compliance
8	Evidence to support Conformity with the Technical Specification-3	<p>Submit the manufacturer's un-amended sales literature, unconditional statements of specification and compliance issued by the manufacturer, samples, independent test data etc., as appropriate of</p> <p>1. Hydraulic Power Unit with Control Panels for (Integrated System); or 2. Motor and Pumps; and Oil Reservoir; and Control System for (Customized System)</p> <p>as evidence of the compliance to the required Technical Specifications (To be included in Envelope 1)</p>	

TO:

Item	Description	NPC Requirements	Supplier's Data and Statement of Compliance
8	Evidence to support Conformity with the Technical Specification-3	<p>Submit the manufacturer's un-amended sales literature, unconditional statements of specification and compliance issued by the manufacturer, samples, independent test data etc., as appropriate of</p> <p>1. Hydraulic Power Unit with Control Panels including the Multi-parameter Sensor and Data Logger for (Integrated</p>	

NPC-009.F17
Rev.No.1
Page 3 of 4

BIR Road cor. Quezon Avenue, Diliman
Quezon City 1100, Philippines
Tel. Nos. (632) 921-3541 to 80
Fax No. (632) 921-2468
Website: www.napocor.gov.ph



Management System
ISO 9001:2015



www.tuv.com
ID: 91866012

		<p>System), or</p> <p>2 Motor and Pumps; and Oil Reservoir, Control System, Multi-parameter Sensor and Data Logger for (Customized System)</p> <p>as evidence of the compliance to the required Technical Specifications (To be included in Envelope 1)</p>	
--	--	---	--

3. Reference hydraulic diagram and electrical wiring: Refer to the attached diagrams

Notes:

1. All other terms published in the previous publication that are not amended by this publication shall remain the same.
2. For further clarification, you may contact us at (063)223-4604

For the information and guidance of all concerned.

REYNANTE T. CIRUELA
 Chairman
 Bids and Awards Committee
 Mindanao Generation

Date of Publication: June 14, 2022



AGIJC E NIVERDCIONM W/EPID DANIAMI CATE

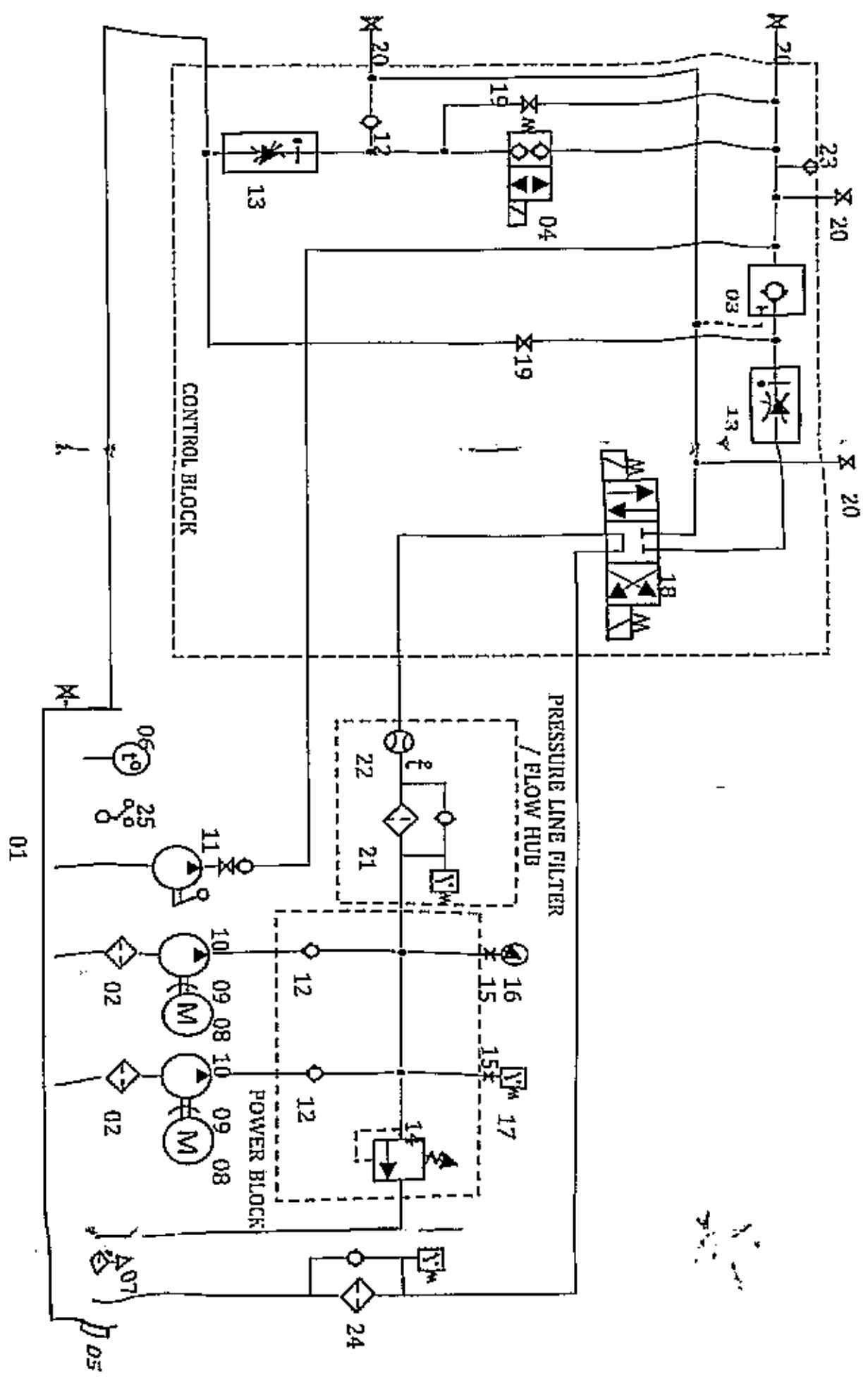

SEQUENCE DIAGRAM

for

DIVERSION WEIR RADIAL GATE

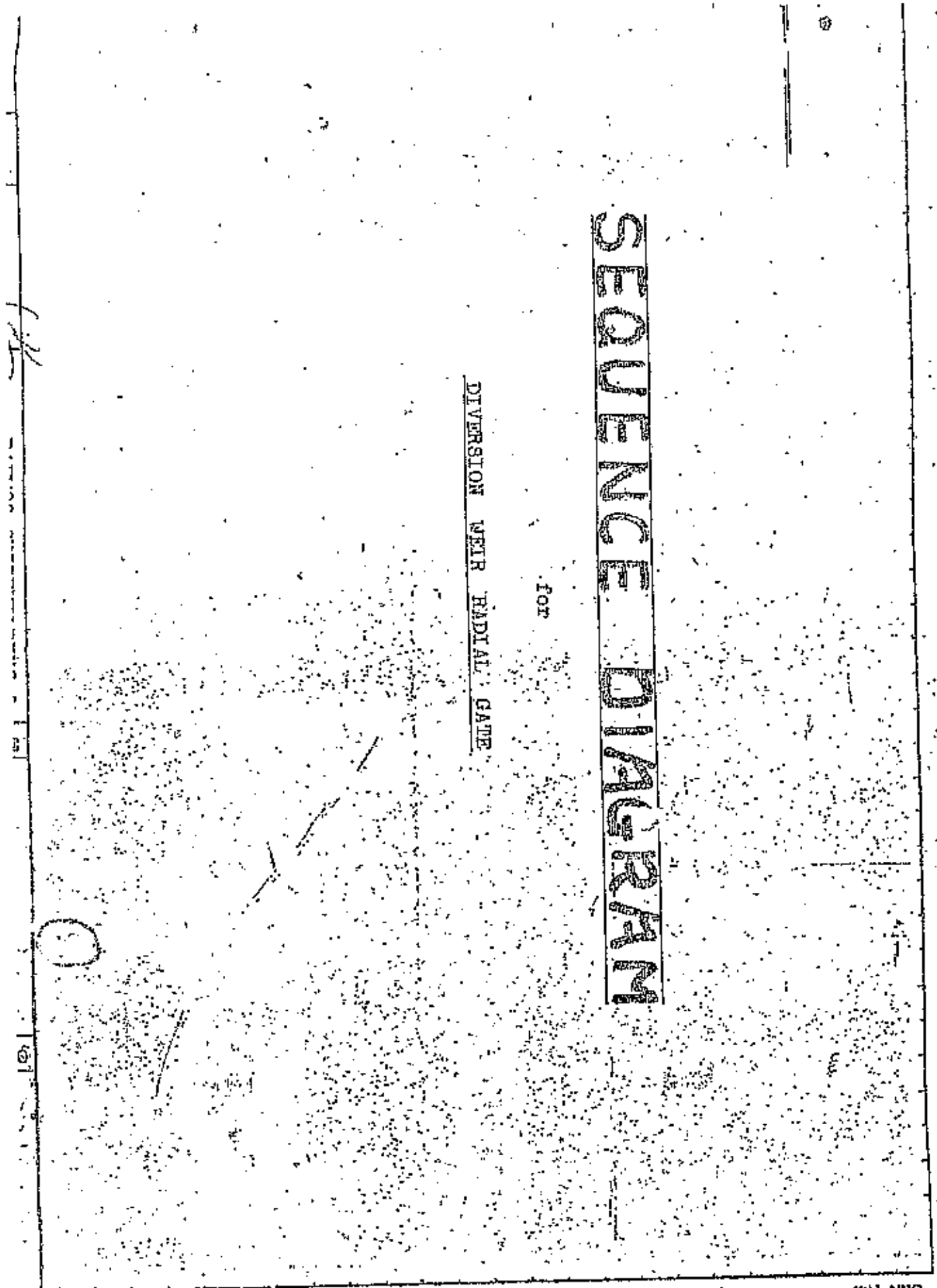

(CAMPER SUPPLY)
600 V. 3Ø 80KVA
POWER SOURCE
AC 460 V 3Ø 60HZ

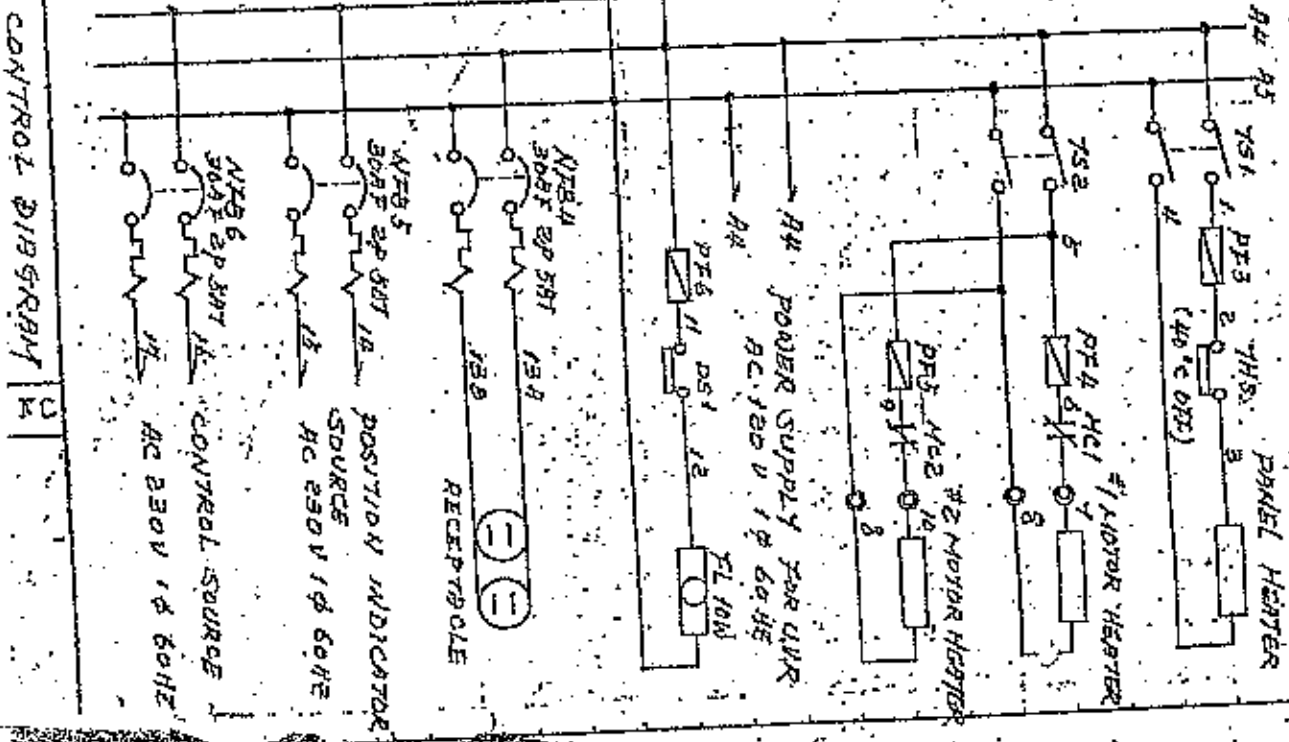
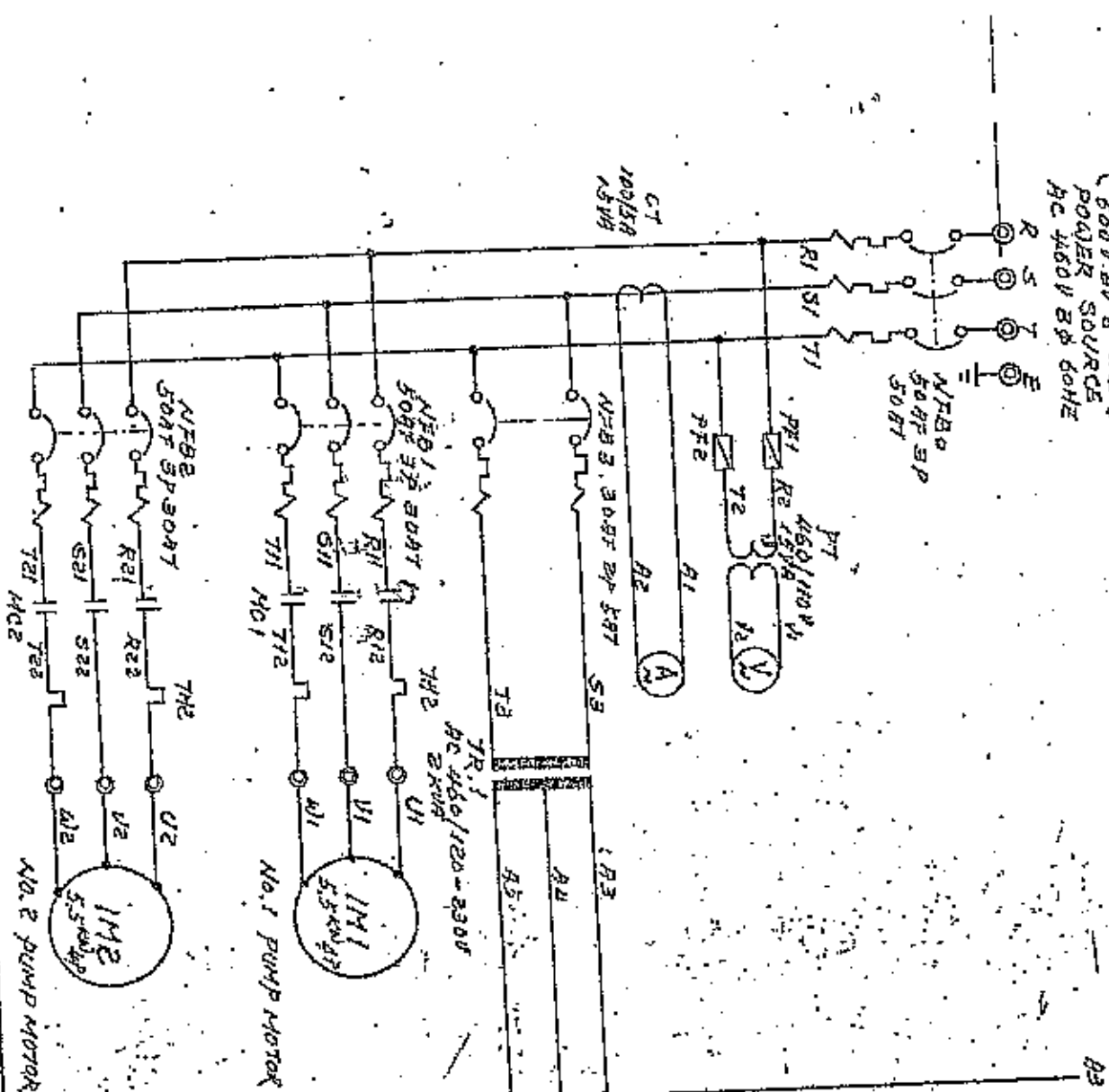

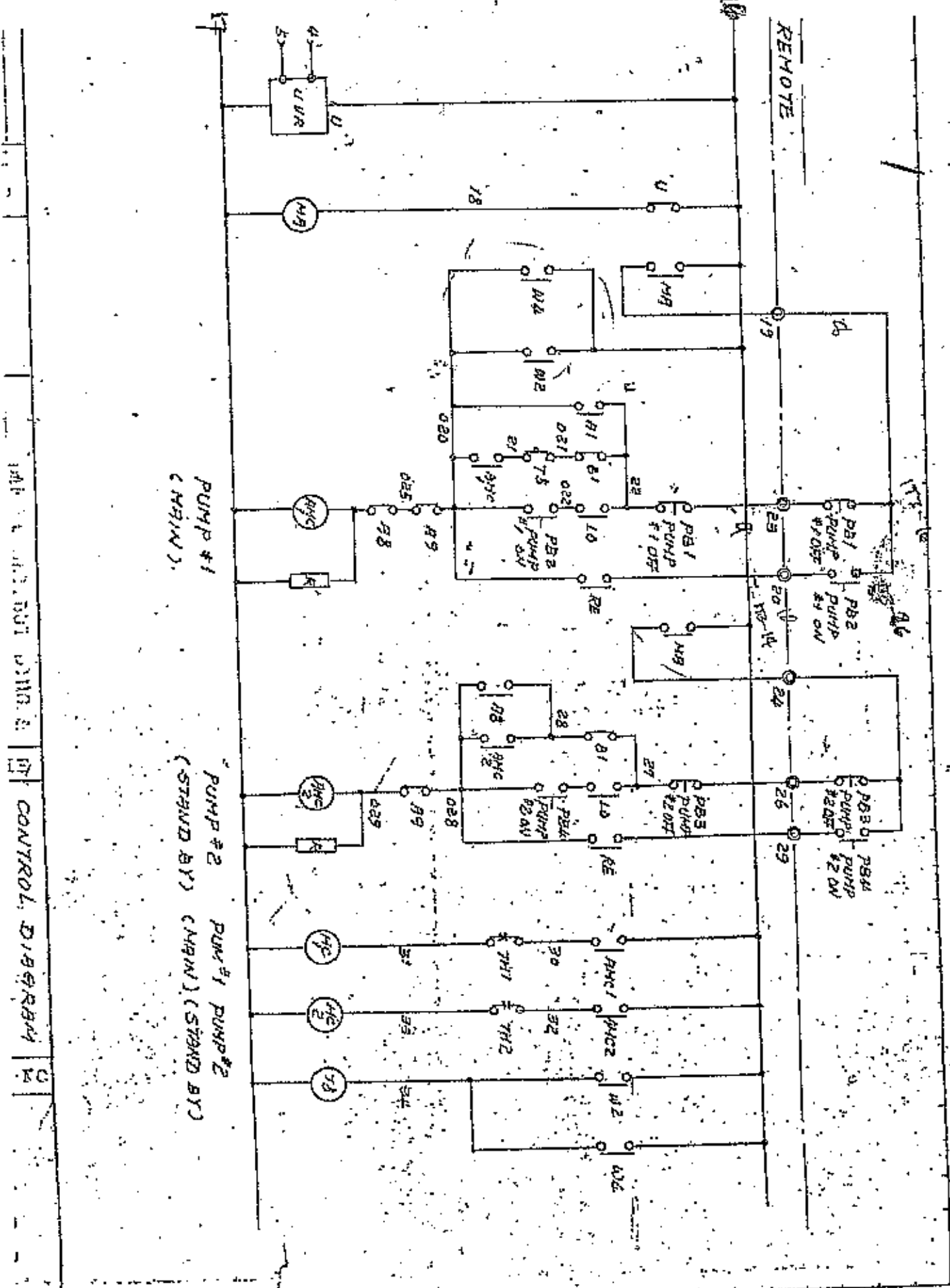

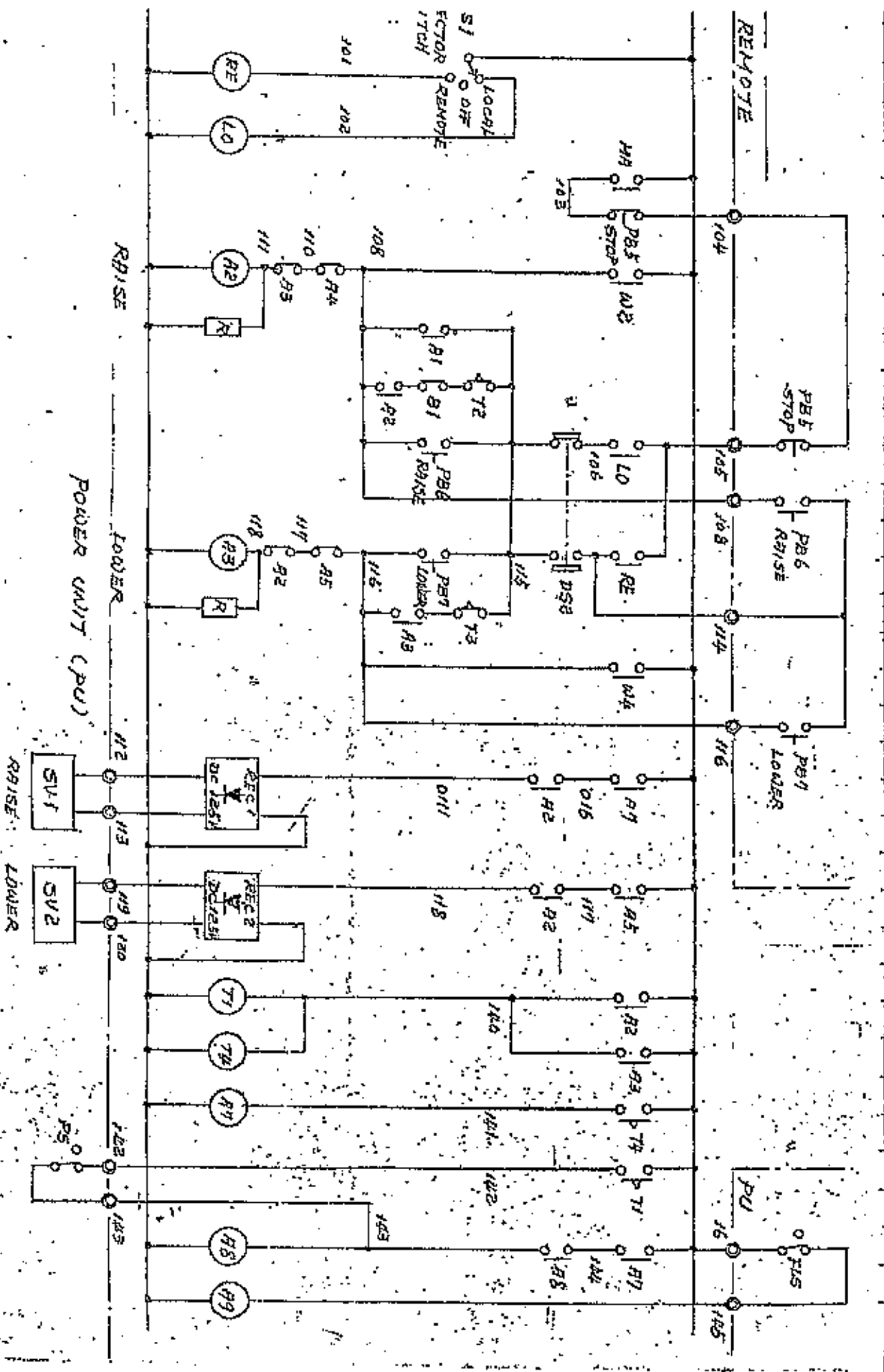

CONTROL DIAGRAM
 3541-E-3

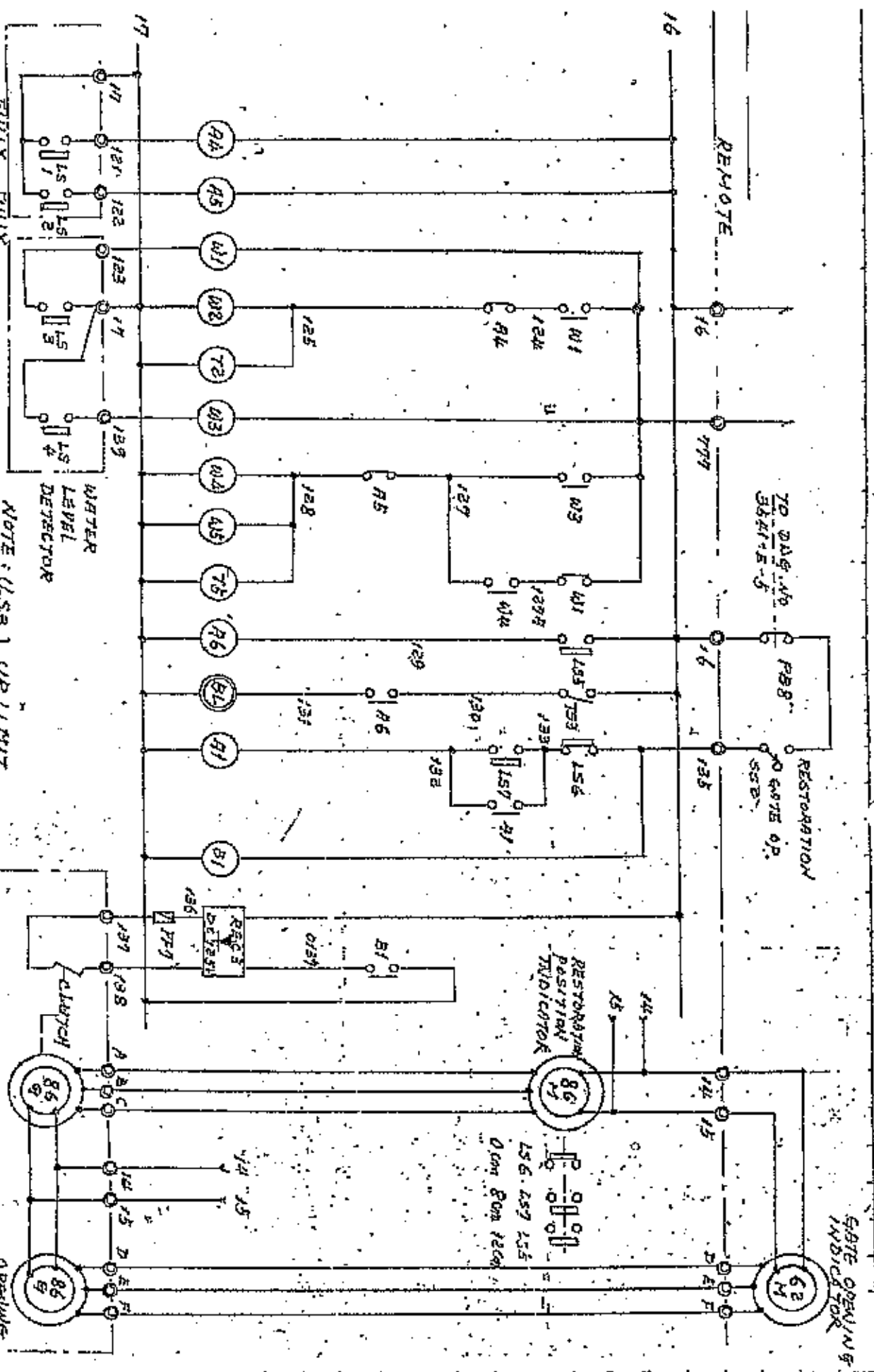

FULLY RAISED LOWERED

WATER LEVEL DETECTOR

NOTE: (LSB) UP LIMIT OF WATER LEVEL

(LSM) DOWN LIMIT OF WATER LEVEL
 RESTORATION TRANSMITTER WITH MECHANICAL INDICATOR

CLATCH

RESTORATION POSITION INDICATOR

GATE OPENING INDICATOR

TO DAG NO 3641-E-5

REMOTE

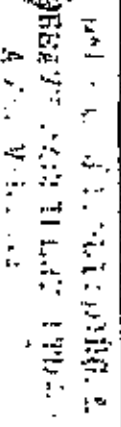

CONTROL DIAGRAM

3641-E-4

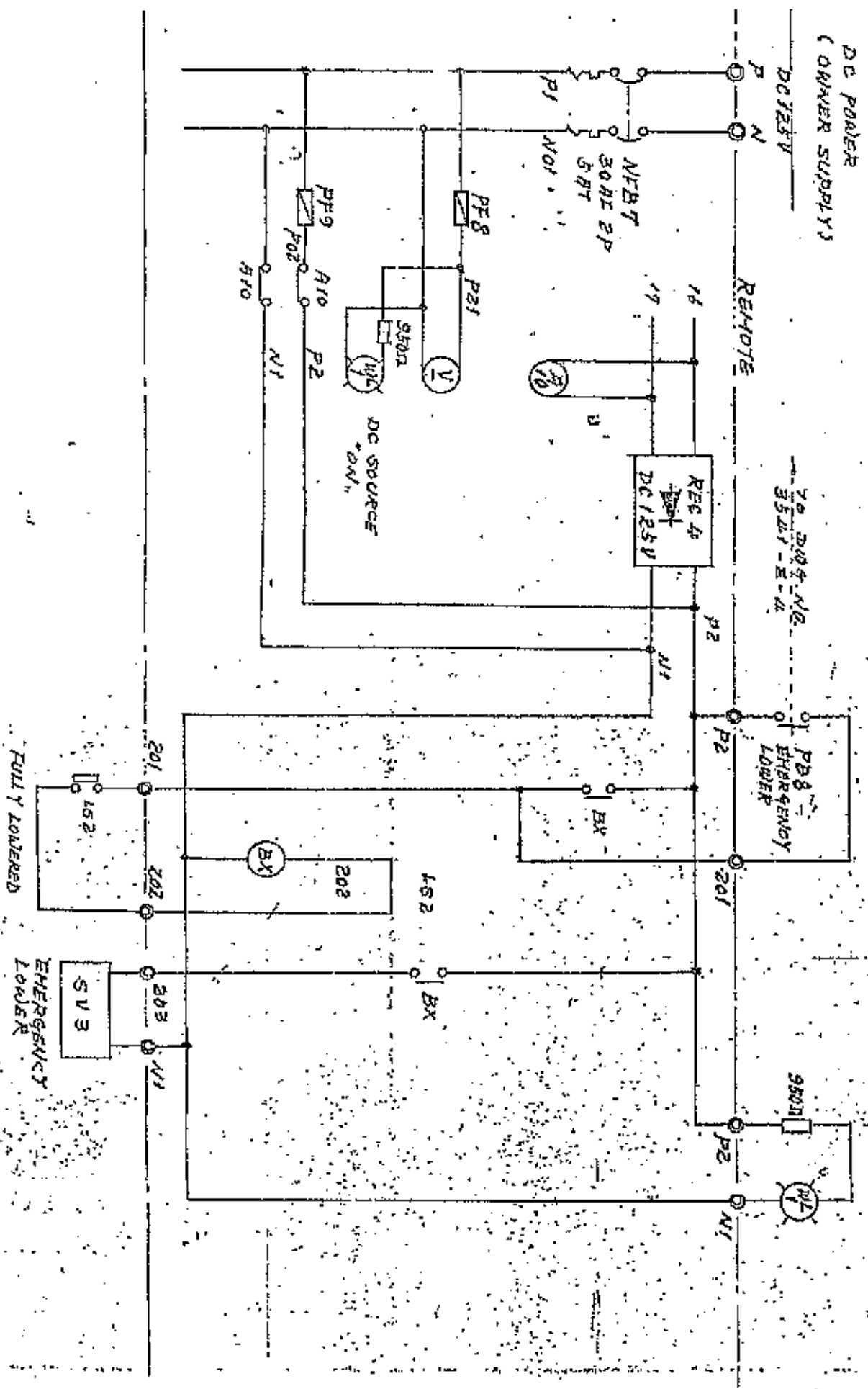

FULLY LOWERED

EMERGENCY LOWER

CONTROL DIAGRAM

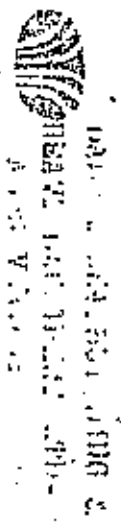

REV	DATE	DESCRIPTION
1		
2		
3		

3541-E-15

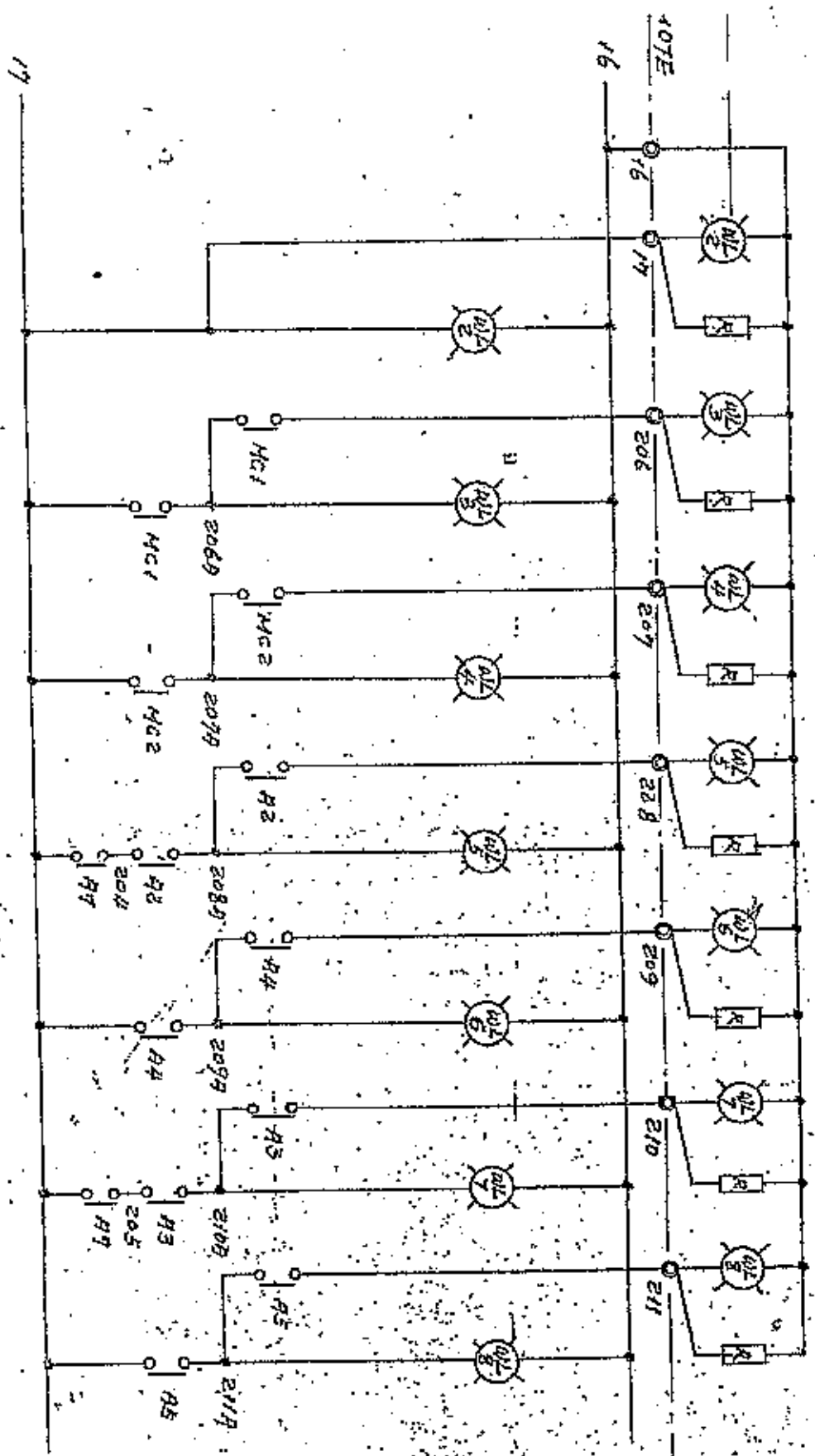



AC SOURCE ON PUM 1 ON PUM 2 ON RAISING RAISED LOWERING LOWERED

FULLY FULLY

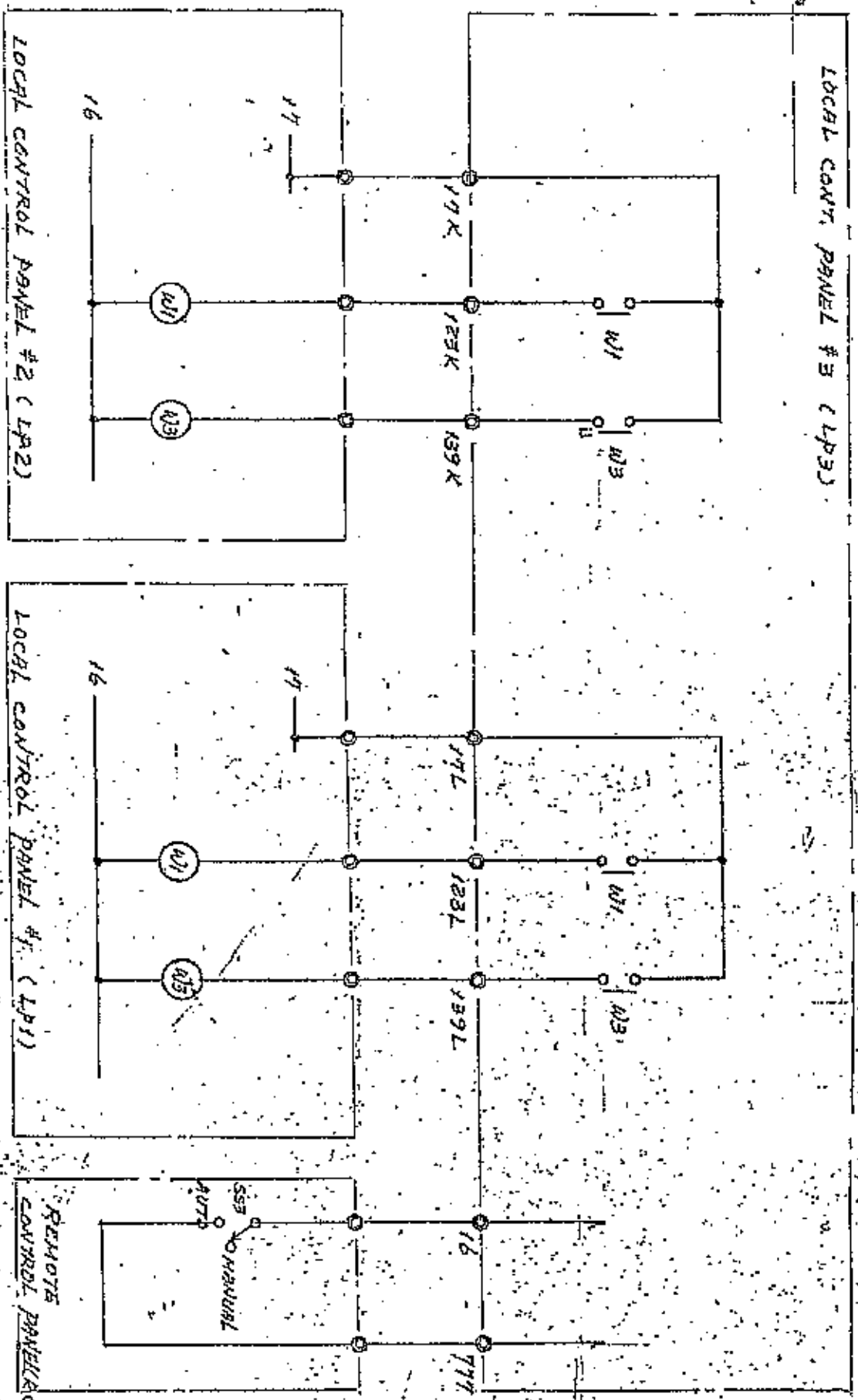
3	CONTROL DIAGRAM	3541-E-6
---	-----------------	----------

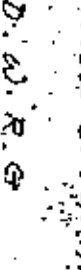

	3		 THE GENERAL BUILDING & CONTRACTING COMPANY 4000 VICTORIA AVENUE VANCOUVER, B.C.	 CONTROL DIAGRAM	 D. A. R. G.	 3541-E-7
--	---	--	---	---	---	--